

Instruction manual

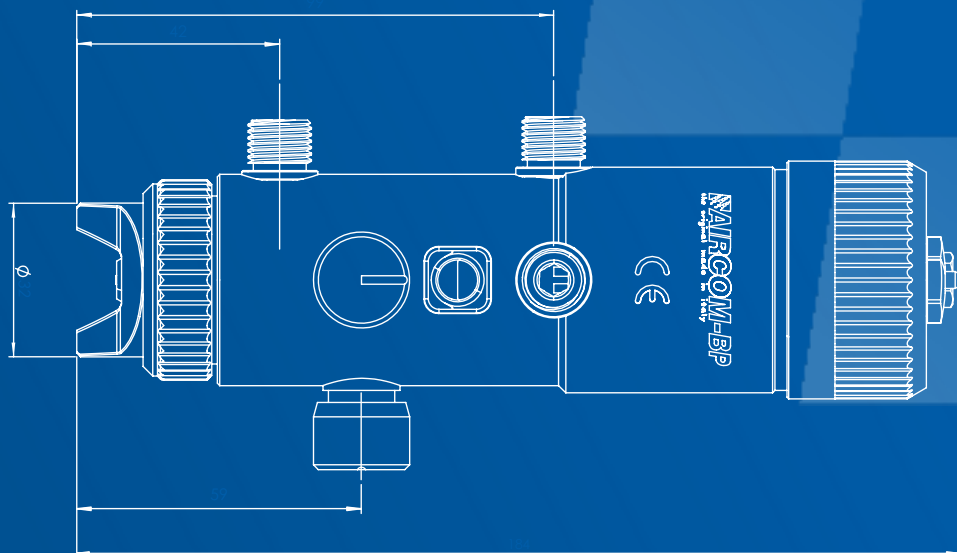

mod. BP, BP-X, BP-XC

AVAILABLE MODELS

mod. BP

Fan and atomization air adjustment

mod. BP-X

Stainless steel internal passages

mod. BP-XC

Stainless steel internal passages and spray head

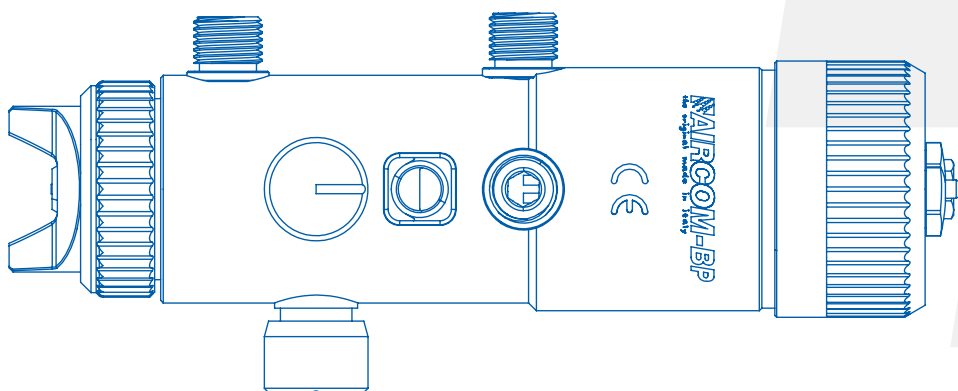

Index

Instruction Manual

Warnings	.04
Maintenance and cleaning	.04
Installation and start-up	.05
Technical data	.08
Troubleshooting	.10
Spare parts and components	.11
Certified quality	.18
Support	.18



WARNINGS!

Carefully read and follow all instructions and safety precautions before using the product.



MANUALS

Our manuals are available at aircom.it/en/support/manuals/
Or, by scanning the QR Code on this page.

WARNINGS

CORROSIVE PRODUCT WARNINGS

Our guns can be used with the majority of water, or solvent-based pigments for coating and finishing all types of surfaces. However, they are not designed to spray abrasive and/or corrosive products. If abrasive and/or corrosive products are used, guns with components made of the appropriate material can be ordered.

HEALTH HAZARD

Some chemicals, once sprayed, may be harmful and cause irritation or health disorders. Careful reading of all labels and instructions on how to use the product are necessary. Use of the product is restricted to trained technical personnel, with the use of special safety glasses when adjusting the gun and, while the system is operating.

MAINTENANCE AND CLEANING

MAINTENANCE

Before any maintenance work, empty the gun and disconnect it from both, the compressed air supply, and the liquid supply. Use only original AIRCOM® accessories, spare parts, and related components: any other product not supplied by AIRCOM® is not approved or authorized. AIRCOM® is not liable for any damage caused by using non-original spare parts and accessories.

CLEANING

Use exclusively appropriate liquid cleaners with neutral pH 6-8. Do not use acids, alkaline solutions or other cleaning agents containing sodium hydroxide, which are aggressive for cleaning the exterior of the gun. Do not immerse the gun in liquid cleaners that may cause corrosion of the product. Clean all material passages by propagating water within the paint circuit: inadequate cleaning can cause damages to the fan shape. While cleaning, avoid scratching the surfaces of the air nozzle holes and the dipstick.

INSTALLATION

TECHNICAL SPECIFICATIONS

Connection hole diameter: 10,5 mm.

Size of pipe junctions:

- Control air inlet: **A** = ¼ gas
- Atomizing air inlet: **B** = ¼ gas
- Product inlet: **C** = ¼ gas

Gun weight: 0,920 kg

Gun size: see dimensioned views

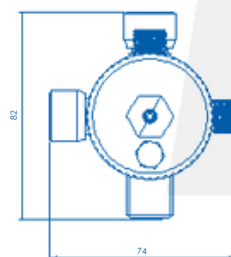
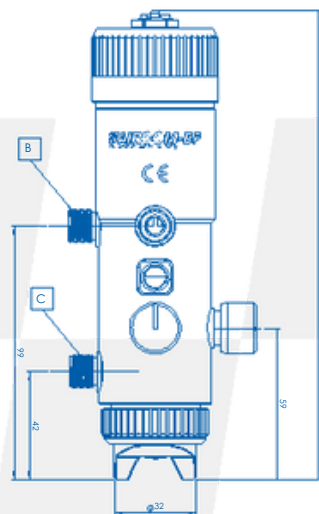
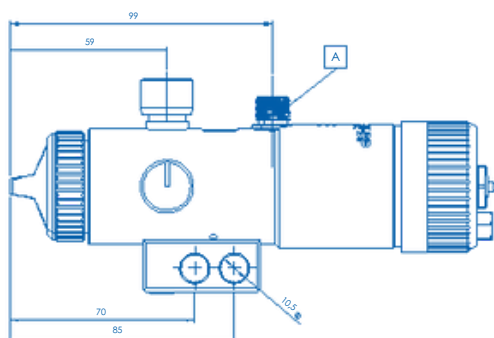

VIDEO TUTORIALS ►

Our video tutorials are available at aircom.it/en/support/tutorials/
Or, by scanning the QR Code on this page.



INSTALLATION AND STARTUP

Before using a new gun or a new product, clean the gun thoroughly with an appropriate solvent. Powering should be done with dry, filtered air and regulated to constant pressure.

DIRECTIONS FOR GUN OPERATION

A

Pipe \varnothing ext. X \varnothing int. = 8 X 6
Plunger opening \geq 4,0 bar

B

Pipe \varnothing ext. X \varnothing int. = 8 X 6
Atomization: from 1,5 to 3,5 bar

C

Pipe \varnothing ext. X \varnothing int. = 8 X 6
Product inlet

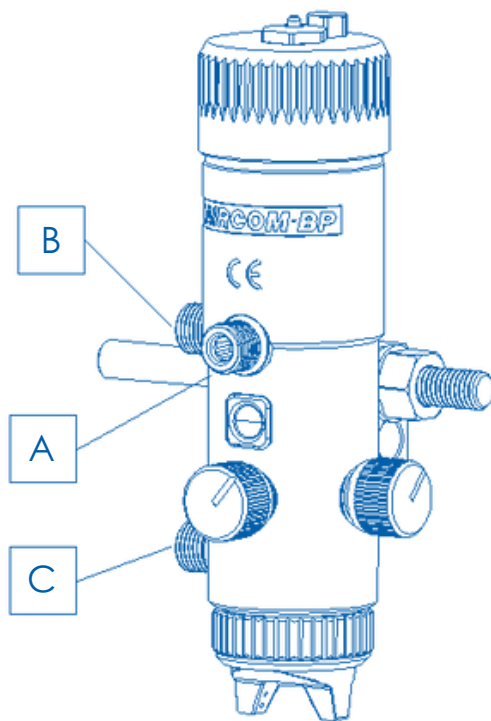

ADJUSTMENT SEQUENCE

1. Lock the gun to the system using the fastening bracket and orient the head towards the appropriate coverage direction.

2. Connect the atomization air, control air and product piping to the junctions shown on the previous page.

3. Screw the handwheel part. [1007-42] as far as it will go (do not force when reaching the stop). Act on the control air. If no drop of pigment comes out, remove the control air, and open the handwheel part. [1007-42] with one click. Repeat the process until the first drop appears.

4. Open the handwheel part. [1007-42] with the necessary clicks to determine the desired amount of pigment.

5. Act on the adjustment screw part. [1007-7] to obtain the desired atomization range.

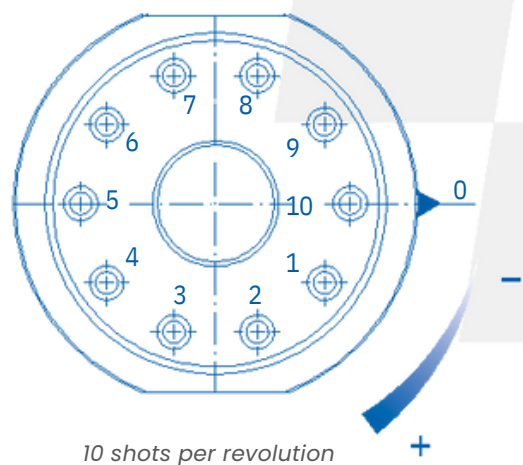

TECHNICAL DATA

HEAD 1007-30-KI

HEAD Ø NOZZLE	SHOTS	FLOW RATE OF THE FLUID (g/min)	ATOMIZATION PRESSURE (kg/cm ²)	AIR CONSUMPTION (l/min)
1007-30-KI Ø 0,8	4	122	1,5	119
	6	197	1,75	132
1007-30-KI Ø 1,0	5	208	1,85	137
	7	306	2,1	149
1007-30-KI Ø 1,2	6	258	2,35	167
	8	349	2,75	189
1007-30-KI Ø 1,5	6	320	2,85	196
	8	456	3,1	209

NOTES

Pump pressure 0.8 to 1.0 Kg/cm².
Liquid used for testing: water. Ford cup viscosity 4 = 11 sec.

TECHNICAL DATA





HEAD 1007-30-ZI

HEAD Ø NOZZLE	SHOTS	FLOW RATE OF THE FLUID (g/min)	ATOMIZATION PRESSURE (kg/cm ²)	AIR CONSUMPTION (l/min)
1007-30-ZI Ø 0,8	4	122	1,3	109
	6	197	1,5	120
1007-30-ZI Ø 1,0	5	208	1,75	135
	7	306	1,95	145
1007-30-ZI Ø 1,2	6	258	2,0	148
	8	349	2,3	166
1007-30-ZI Ø 1,5	6	320	2,45	180
	8	456	2,8	200

NOTES

Pump pressure 0.8 to 1.0 Kg/cm².
Liquid used for testing: water. Ford cup viscosity 4 = 11 sec.

TROUBLESHOOTING

Anomaly	Problem / Solution
No atomization	No pressure is getting to the gun <i>Check air system</i>
	Valve part. [1007-43] worn out <i>Replace valve part. [1007-43] worn out</i>
	The head part. [1007-30], nozzle part. [1007-2] and needle part. [1056-31] are worn out. <i>Replace the head part. [1007-30], the nozzle part. [1007-2] and the needle part. [1056-31]</i>
	The product is exceeding the amount needed <i>Reduce the product passage</i>
	Lack of product (flow rate too low) <i>Add product or reduce atomization air pressure</i>
	Missing product in tank or clogged pipes <i>Fill tank or clean up with solvent</i>
Leakage from the nozzle	Mounted handwheel part. [1007-42] worn out <i>Replace mounted handwheel part. [1007-42] worn out</i>
Air leakage from the adjustment screw	Gasket part. [B] <i>Replace gasket part. [B]</i>
Leakage of product from the vent	Gasket kit part. [1007-46 e 1007-47] worn out <i>Replace gasket kit part. [1007-46 e 1007-47]</i>

Spare parts and components

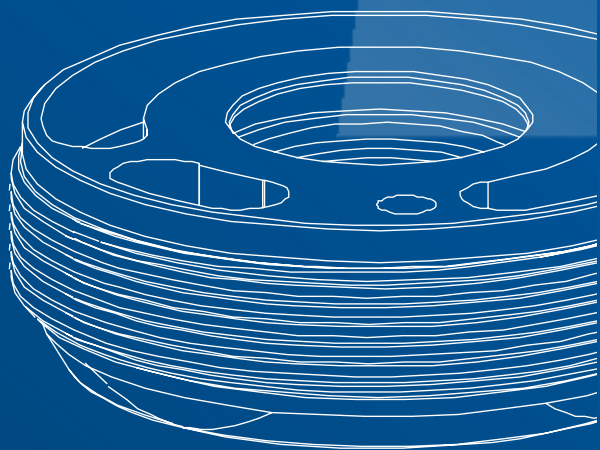
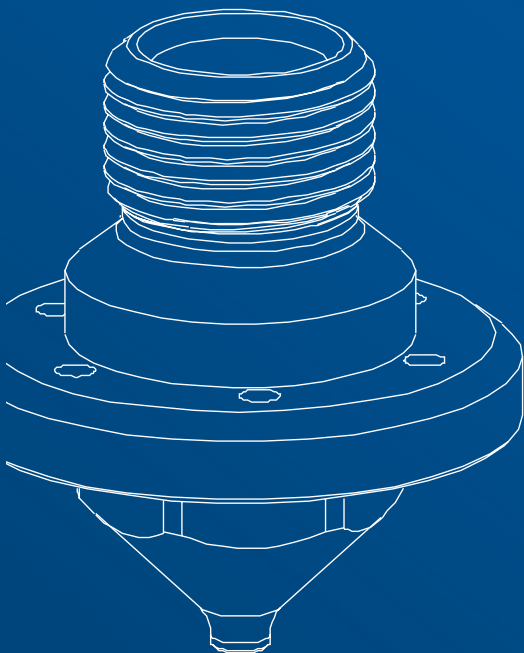

SPARE PARTS

DETAILS LIST

- 1007-2** [x1] Nozzle
- 1007-3** [x1] Ferrule
- 1007-7-B** [x2] Adjusting screw
- 1007-28** [x1] Cap
- 1007-30** [x1] Head
- 1056-31** [x1] Complete needle
- 1007-34** [x1] Gasket cover ring
- 1007-35** [x1] Valve
- 1007-36** [x1] Mounted plunger
- 37** [x1] Seeger
- 38** [x1] Gasket
- 39** [x1] Gasket
- 1007-40** [x1] Spring
- 1007-42** [x1] Mounted hand wheel
- 1007-43** [x1] Mounted valve
- 1007-46** [x1] Gasket kit
- 1007-47** [x1] Gasket kit
- 1007-101** [x1] Plunger
- B** [x2] Gasket
- G** [x1] Gasket
- 1008-G16** [x1] Body with internal bushing in brass, regulating valves and bracket block.
- L** [x2] Gasket
- N** [x2] Gasket
- 1007-R1** [x3] Junction

mod. BP

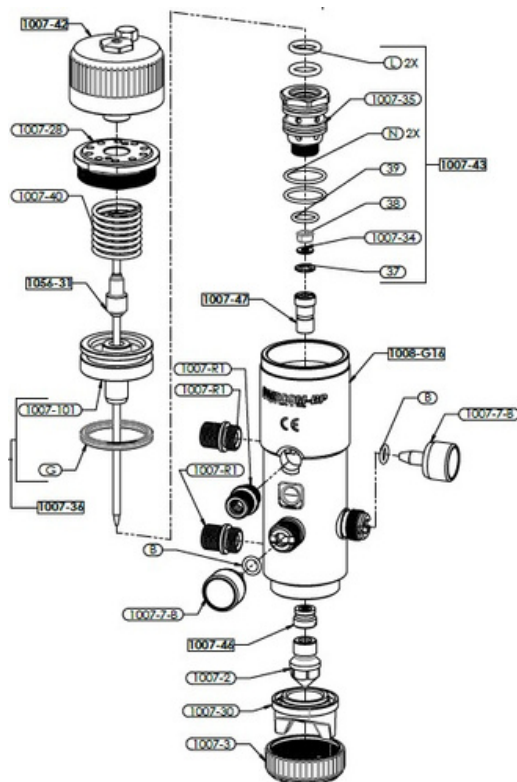

NOTES

The head protection stopper is also available as a spare part. You can refer to the CNN table below for compatible heads for your model.

SPARE PARTS

DETAILS LIST

- 1007-2 [x1] Nozzle
- 1007-3 [x1] Ferrule
- 1007-7-B [x2] Adjusting screw
- 1007-28 [x1] Cap
- 1007-30 [x1] Head
- 1056-31 [x1] Complete needle
- 1007-34 [x1] Gasket cover ring
- 1007-35 [x1] Valve
- 1007-36 [x1] Mounted plunger
- 37 [x1] Seeger
- 38 [x1] Gasket
- 39 [x1] Gasket
- 1007-40 [x1] Spring
- 1007-42 [x1] Mounted hand wheel
- 1007-43 [x1] Mounted valve
- 1007-46-X [x1] Stainless steel gasket kit
- 1007-47 [x1] Gasket kit
- 1007-101 [x1] Plunger
- B [x2] Gasket
- G [x1] Gasket
- 1008-G16-X [x1] Body with internal bushing in stainless steel, regulating valves and bracket block.
- L [x2] Gasket
- N [x2] Gasket
- 1007-R1-X [x3] Stainless steel junction

mod. BP-X

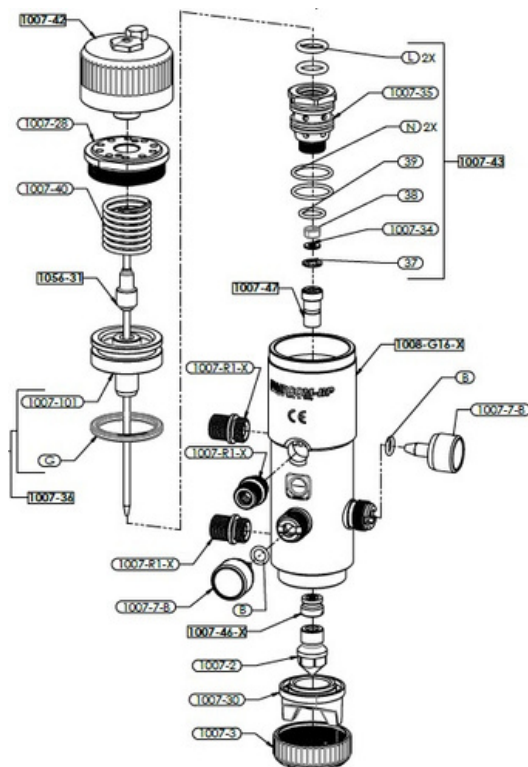

NOTES

The head protection stopper is also available as a spare part. You can refer to the CNN table below for compatible heads for your model.

SPARE PARTS

DETAILS LIST

- 1007-2** [x1] Nozzle
- 1007-3** [x1] Ferrule
- 1007-7-B** [x2] Adjusting screw
- 1007-28** [x1] Cap
- 1007-30-X** [x1] Stainless steel head
- 1056-31** [x1] Complete needle
- 1007-34** [x1] Gasket cover ring
- 1007-35** [x1] Valve
- 1007-36** [x1] Mounted plunger
- 37** [x1] Seeger
- 38** [x1] Gasket
- 39** [x1] Gasket
- 1007-40** [x1] Spring
- 1007-42** [x1] Mounted hand wheel
- 1007-43** [x1] Mounted valve
- 1007-46-X** [x1] Stainless steel gasket kit
- 1007-47** [x1] Gasket kit
- 1007-101** [x1] Plunger
- B** [x2] Gasket
- G** [x1] Gasket
- 1008-G16-X** [x1] Body with internal bushing in stainless steel, regulating valves and bracket block
- L** [x2] Gasket
- N** [x2] Gasket
- 1007-R1-X** [x3] Stainless steel junction

mod. BP-XC

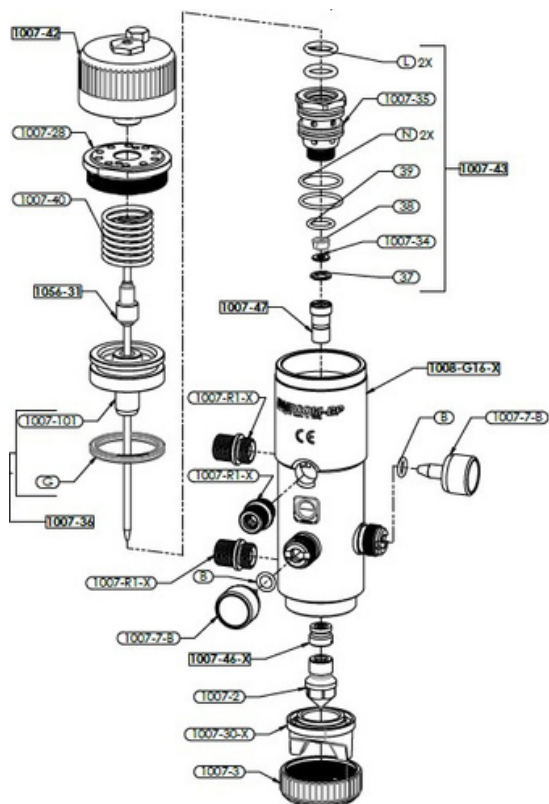



NOTES



The head protection stopper is also available as a spare part. You can refer to the CNN table below for compatible heads for your model.

COMPATIBLE CNN

Cap-Nozzle-Needle

mod. BP, BP-X



1007-30-KI	CAP	NOZZLE	NEEDLE
 	1007-30-KI-0.8	1007-2-0.8	1056-31-0.8
	1007-30-KI-1.0	1007-2-1.0	1056-31-1.0
	1007-30-KI-1.2	1007-2-1.2	1056-31-1.2
	1007-30-KI-1.5	1007-2-1.5	1056-31-1.5
	1007-30-KI-1.8	1007-2-1.8	1056-31-1.8
	1007-30-KI-2.0	1007-2-2.0	1056-31-2.0
	1007-30-KI-2.2	1007-2-2.2	1056-31-2.2
	1007-30-KI-2.5	1007-2-2.5	1056-31-2.5
	1007-30-KI-3.0	1007-2-3.0	1056-31-3.0



1007-30-ZI	CAP	NOZZLE	NEEDLE
 	1007-30-ZI-0.8	1007-2-0.8	1056-31-0.8
	1007-30-ZI-1.0	1007-2-1.0	1056-31-1.0
	1007-30-ZI-1.2	1007-2-1.2	1056-31-1.2
	1007-30-ZI-1.5	1007-2-1.5	1056-31-1.5
	1007-30-ZI-1.8	1007-2-1.8	1056-31-1.8
	1007-30-ZI-2.0	1007-2-2.0	1056-31-2.0
	1007-30-ZI-2.2	1007-2-2.2	1056-31-2.2
	1007-30-ZI-2.5	1007-2-2.5	1056-31-2.5
	1007-30-ZI-3.0	1007-2-3.0	1056-31-3.0

COMPATIBLE CNN

Cap-Nozzle-Needle

mod. BP, BP-X



1007-30-WI	CAP	NOZZLE	NEEDLE
 	1007-30-WI-0.8	1007-2-0.8	1056-31-0.8
	1007-30-WI-1.0	1007-2-1.0	1056-31-1.0
	1007-30-WI-1.2	1007-2-1.2	1056-31-1.2
	1007-30-WI-1.5	1007-2-1.5	1056-31-1.5
	1007-30-WI-1.8	1007-2-1.8	1056-31-1.8
	1007-30-WI-2.0	1007-2-2.0	1056-31-2.0
	1007-30-WI-2.2	1007-2-2.2	1056-31-2.2
	1007-30-WI-2.5	1007-2-2.5	1056-31-2.5
1007-30-WI-3.0	1007-2-3.0	1056-31-3.0	



1007-30-NI	CAP	NOZZLE	NEEDLE
 	1007-30-NI-0.8	1007-2-0.8	1056-31-0.8
	1007-30-NI-1.0	1007-2-1.0	1056-31-1.0
	1007-30-NI-1.2	1007-2-1.2	1056-31-1.2
	1007-30-NI-1.5	1007-2-1.5	1056-31-1.5
	1007-30-NI-1.8	1007-2-1.8	1056-31-1.8
	1007-30-NI-2.0	1007-2-2.0	1056-31-2.0
	1007-30-NI-2.2	1007-2-2.2	1056-31-2.2
	1007-30-NI-2.5	1007-2-2.5	1056-31-2.5
1007-30-NI-3.0	1007-2-3.0	1056-31-3.0	

COMPATIBLE CNN

Cap-Nozzle-Needle

mod. BP, BP-X

1007-30-TI	CAP	NOZZLE	NEEDLE
 	1007-30-TI-0.8	1007-2-0.8	1056-31-0.8
	1007-30-TI-1.0	1007-2-1.0	1056-31-1.0
	1007-30-TI-1.2	1007-2-1.2	1056-31-1.2
	1007-30-TI-1.5	1007-2-1.5	1056-31-1.5
	1007-30-TI-1.8	1007-2-1.8	1056-31-1.8
	1007-30-TI-2.0	1007-2-2.0	1056-31-2.0
	1007-30-TI-2.2	1007-2-2.2	1056-31-2.2
	1007-30-TI-2.5	1007-2-2.5	1056-31-2.5
	1007-30-TI-3.0	1007-2-3.0	1056-31-3.0

1007-30-UI *	CAP	NOZZLE	NEEDLE
 	1007-30-UI-0.8	1007-2-U-0.8	1056-31-U-0.8
	1007-30-UI-1.0	1007-2-U-1.0	1056-31-U-1.0
	1007-30-UI-1.2	1007-2-U-1.2	1056-31-U-1.2
	1007-30-UI-1.5	1007-2-U-1.5	1056-31-U-1.5
	1007-30-UI-1.8	1007-2-U-1.8	1056-31-U-1.8
	1007-30-UI-2.0	1007-2-U-2.0	1056-31-U-2.0
	1007-30-UI-2.2	1007-2-U-2.2	1056-31-U-2.2
	1007-30-UI-2.5	1007-2-U-2.5	1056-31-U-2.5
	1007-30-UI-3.0	1007-2-U-3.0	1056-31-U-3.0

* self-cleaning

COMPATIBLE CNN

Cap-Nozzle-Needle

mod. BP, BP-X

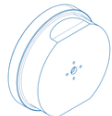
1007-30-SF	CAP	NOZZLE	NEEDLE
 	1007-30-SF-0.8	1007-2-0.8	1056-31-0.8
	1007-30-SF-1.0	1007-2-1.0	1056-31-1.0
	1007-30-SF-1.2	1007-2-1.2	1056-31-1.2
	1007-30-SF-1.5	1007-2-1.5	1056-31-1.5
	1007-30-SF-1.8	1007-2-1.8	1056-31-1.8
	1007-30-SF-2.0	1007-2-2.0	1056-31-2.0
	1007-30-SF-2.2	1007-2-2.2	1056-31-2.2
	1007-30-SF-2.5	1007-2-2.5	1056-31-2.5
	1007-30-SF-3.0	1007-2-3.0	1056-31-3.0

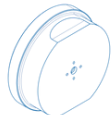

mod. BP-XC



1007-30-SFX	CAP	NOZZLE	NEEDLE
 	1007-30-SFX-0.8	1007-2-0.8	1056-31-0.8
	1007-30-SFX-1.0	1007-2-1.0	1056-31-1.0
	1007-30-SFX-1.2	1007-2-1.2	1056-31-1.2
	1007-30-SFX-1.5	1007-2-1.5	1056-31-1.5
	1007-30-SFX-1.8	1007-2-1.8	1056-31-1.8
	1007-30-SFX-2.0	1007-2-2.0	1056-31-2.0
	1007-30-SFX-2.2	1007-2-2.2	1056-31-2.2
	1007-30-SFX-2.5	1007-2-2.5	1056-31-2.5
	1007-30-SFX-3.0	1007-2-3.0	1056-31-3.0

COMPATIBLE CNN

Cap-Nozzle-Needle

mod. BP-XC

1007-30-KX	CAP	NOZZLE	NEEDLE
 	1007-30-KX-0.8	1007-2-0.8	1056-31-0.8
	1007-30-KX-1.0	1007-2-1.0	1056-31-1.0
	1007-30-KX-1.2	1007-2-1.2	1056-31-1.2
	1007-30-KX-1.5	1007-2-1.5	1056-31-1.5
	1007-30-KX-1.8	1007-2-1.8	1056-31-1.8
	1007-30-KX-2.0	1007-2-2.0	1056-31-2.0
	1007-30-KX-2.2	1007-2-2.2	1056-31-2.2
	1007-30-KX-2.5	1007-2-2.5	1056-31-2.5
1007-30-KX-3.0	1007-2-3.0	1056-31-3.0	

1007-30-ZX	CAP	NOZZLE	NEEDLE
 	1007-30-ZX-0.8	1007-2-0.8	1056-31-0.8
	1007-30-ZX-1.0	1007-2-1.0	1056-31-1.0
	1007-30-ZX-1.2	1007-2-1.2	1056-31-1.2
	1007-30-ZX-1.5	1007-2-1.5	1056-31-1.5
	1007-30-ZX-1.8	1007-2-1.8	1056-31-1.8
	1007-30-ZX-2.0	1007-2-2.0	1056-31-2.0
	1007-30-ZX-2.2	1007-2-2.2	1056-31-2.2
	1007-30-ZX-2.5	1007-2-2.5	1056-31-2.5
1007-30-ZX-3.0	1007-2-3.0	1056-31-3.0	

CERTIFIED QUALITY

CERTIFICATIONS

All AIRCOM® products are certified according to norm EN 13 966 - 1 (VDMA-Einheitsblatt 24 366) and therefore also according to transfer efficiency parameters.



THREE-COLOR INSERT

Each gun is marked with a three-color three-dimensional seal. It represents an additional guarantee of authenticity and Italianity because it is present exclusively in original AIRCOM® guns.



SUPPORT

DO YOU NEED HELP?

We are at your disposal.



+39 0124 5154 44



aircom@aircom.it



Online support



DISCOVER ALL PRODUCTS



Follow us



aircom.it